

DC Voltage and Current Meter

Coulometer

Model: KG-F Series

User Manual



Guaranty and Declaration

Copyright

Hangzhou Junce Instruments Co., Ltd. all right reserved.

Trademark Information

JUNCTEK is a registered trademark of Hangzhou Junce Instruments Co., Ltd.

Notices

JUNCTEK products are covered by P.R.C. patents, issued and pending.
This document replaces all previously published documentation.

Contact Us

If you have any problem or requirement when using our products or this manual, please contact JUNCTEK.

E-mail: junce@junteks.com

Website: www.junteks.com

Safety Requirement

General Safety Summary

Please review the following safety precautions carefully before putting the meter into operation so as to avoid any personal injury or damage to the meter and any product connected to it. To prevent potential hazards, please follow the instructions specified in this manual to use the meter properly.

Observe All Terminal Ratings

To avoid fire or shock hazard, observe all ratings and markers on the meter and check your manual for more information about ratings before connecting the meter.

Use Proper Over-voltage Protection

Ensure that no over-voltage (such as that caused by a bolt of lightning) can reach the product. Otherwise, the operator might be exposed to the danger of an electric shock.

Do Not Operate Without Covers

Do not operate the meter with covers or panels removed.

Do Not Insert Anything Into the Air Outlet

Do not insert anything into the air outlet to avoid damage to the meter.

Avoid Circuit or Wire Exposure

Do not touch exposed junctions and components when the unit is powered on.

Do Not Operate With Suspected Failures

If you suspect that any damage may occur to the meter, have it inspected by JUNCTEK authorized personnel before further operations. Any maintenance, adjustment or replacement especially to circuits or accessories must be performed by JUNCTEK authorized personnel.

Provide Adequate Ventilation

Inadequate ventilation may cause an increase of temperature in the meter, which would cause damage to the meter. So please keep the meter well ventilated and inspect the air outlet and the fan regularly.

Do Not Operate in Wet Conditions

To avoid short circuit inside the meter or electric shock, never operate the meter in a humid environment.

Do Not Operate in an Explosive Atmosphere

To avoid personal injuries or damage to the meter, never operate the meter in an explosive atmosphere.

Keep Meter Surfaces Clean and Dry

To avoid dust or moisture from affecting the performance of the meter, keep the surfaces of the meter clean and dry.

Prevent Electrostatic Impact

Operate the meter in an electrostatic discharge protective environment to avoid damage induced by static discharges. Always ground both the internal and external conductors of cables to release static before making connections.

Handle with Caution

Please handle with care during transportation to avoid damage to keys, knobs, interfaces, and other parts on the panels.

Notices

1. Do not exceed the voltage and current range of the meter, otherwise the meter will be damaged.
2. The positive and negative poles cannot be reversed, and the reverse connection cannot be handled correctly.
3. The shell of the meter is fragile and easy to corrode. Please don't hit or close to chemicals to avoid corrosion.
4. Storage temperature: -25~50°C, and keep the meter in a dry environment.
5. Do not attempt to disassemble the meter, it will void the warranty. There are no user-serviceable parts inside the meter. Repairs can only be made through designated repair outlets or sent back to the factory.
6. The display screen is a fragile device, please do not touch or bump it . Please avoid children playing with the meter. When there is dirt on the LCD surface, wipe it carefully with a soft cloth.
7. Please do not move the meter violently to avoid causing irreparable damage to the internal circuit. If the meter does not work properly, please contact the supplier!

Contents

General Safety Summary	II
Notices	III
1.Brief Introduction	3
2.Dimensions	3
3.Specification	4
1.Introduction of display module	6
2.Introduction of the measuring module	7
3.Introduction of the Sampler	9
4.Introduction of the display interface	10
1.System settings	12
2.Wiring method	20
3.Communication protocol control	22
4.Mobile APP control	27
Appendix 1: English and abbreviations of the interface	46

Inspection

When you get a new KG-F series coulometer, it is recommended that you inspect the meter according to the following steps.

Inspect the Packaging

If the packaging has been damaged, do not dispose the damaged packaging or cushioning materials until the shipment has been checked for completeness and has passed both electrical and mechanical tests. The consigner or carrier shall be liable for the damage to the meter resulting from shipment. We would not be responsible for free maintenance/rework or replacement of the meter.

Check the Contents

Please check the contents according to the packing lists. If the meter is damaged or incomplete, please contact your JUNCTEK sales representative.

Host	KG-F series of Measuring module	1pc
	KG-F series of display module	1pc
	KG-F series of the Sampler	1pc
Accessory	3m communication cable	1pc
	Temperature Sensor	1pc
	4P connection cable	1pc
	3P connection cable (external relay cable)	1pc
	Terminal	1pc
	Quick guide	1pc

Inspect the Meter

In case of any mechanical damage, missing parts, or failure in passing the electrical and mechanical tests, contact your JUNCTEK sales representative.

Chapter I Overview

1. Brief Introduction

The KG-F series voltage and current meter is a new type of coulometer that can measure various parameters such as voltage, current, power, charge and discharge AH value, watt-hours, time, etc. It can also set parameters to achieve multi protection functions such as over-voltage protection, under-voltage protection, over-current protection, over-power protection, over temperature protection and time limit protection. The meter can automatically identify the direction of the current, and can monitor the battery capacity in real time and display the measured data in color LCD screen. The KG-F series voltage and current meters add voltage and current curve display and export functions on the basis of the original functions. At the same time, you can use the mobile APP and the computer to control the measuring module, and the firmware can also be updated in real time.

2. Dimensions

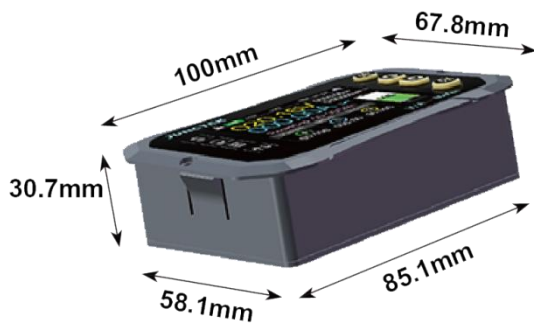

Dimension of display module

Note: display module inlay hole size: 85.1 * 58.1mm

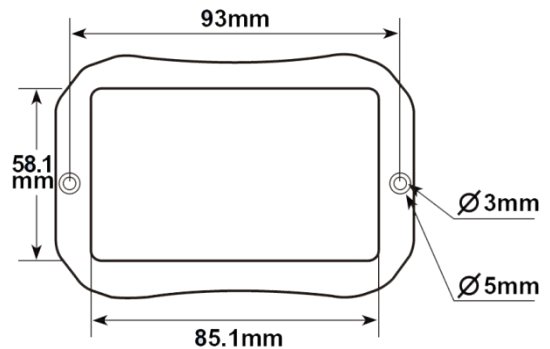

Display module hole bitmap



Dimension of measuring module

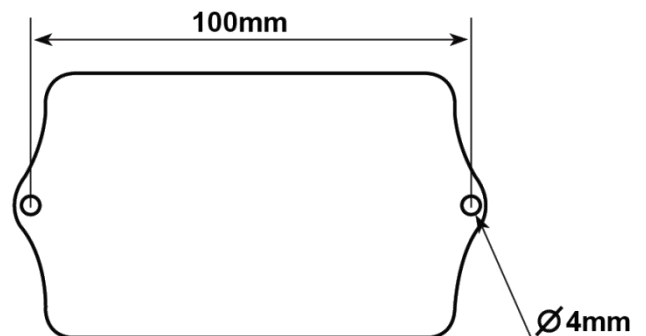

Hole location of measuring module

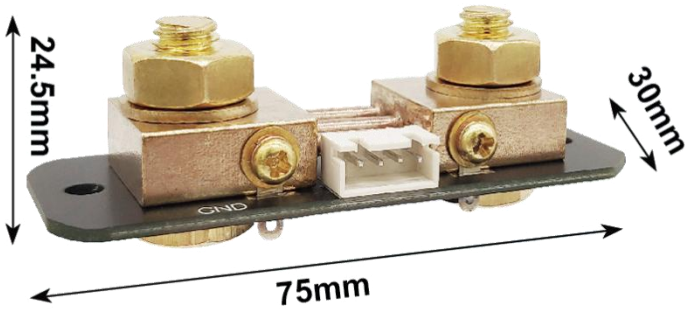

Dimension of the 100A sampler

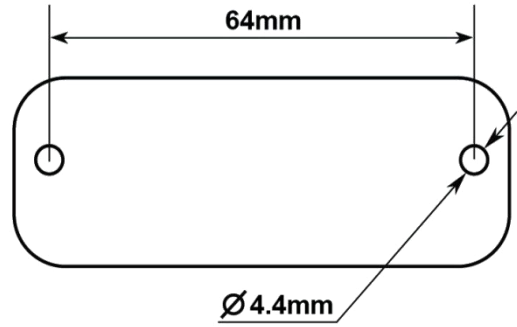

Dimension of the 100A sampler

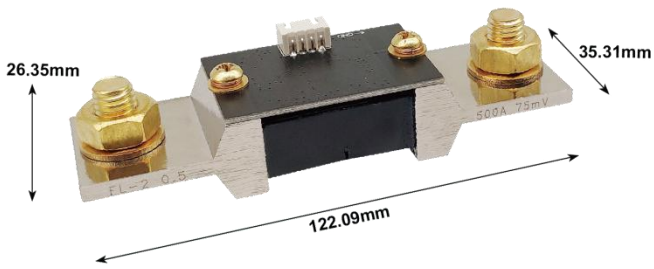

Dimension of the 400A sampler

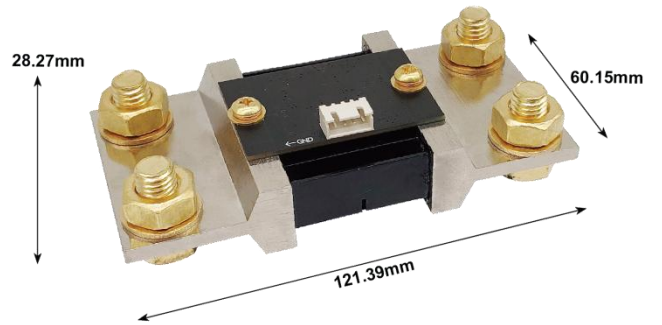

Dimension of the 600A sampler

3.Specification

Model	KG110F	KG140F	KG160F
Sampling method	The Shunt	The Shunt	The Shunt
Voltage measurement range (External power supply)	0-120V	0-120V	0-120V
Voltage measurement range (Self-powered)	10-120V	10-120V	10-120V
Voltage resolution	0.01V	0.01V	0.01V
Current measurement range	0~100A	0~400A	0~600A
Current resolution	0.01A	0.1A	0.1A
Relay	Optional		

Temperature measurement range	-20-120℃		
Capacity display range	0%~100%		
Power measurement range	0~72KW		
Power resolution	0.01W		
AH measurement range	0~9999.99AH		
Capacity resolution	0.001AH		
Watt-hour measurement range	0~9999.99kWH		
Watt-hour accuracy	0.001WH		
Time measurement range	0~999:59:59S		
Time resolution	1 second		
Bluetooth communication distance	10m		
Voltage accuracy	±1%+2 ↑ digits		
Current accuracy	±1%+0.02A,	±1%+0.1A	±1%+0.1A
Sampling rate	1 time / second		
Measuring module power consumption	About 0.4W		
Display module power consumption	About 0.5W		
Over power protection	0-99999.99W		
Negative over current protection	100A/400A/600A		
Forward over	100A/400A/600A		

current protection	
Over voltage protection	0~120V
Under voltage protection	0~120V
External over temperature protection	0-120℃
Protection recovery time	0-99s
Enter standby time	0-60s/Auto (I=0 and time>20s)
Delay time setting	0-99S
Communication address	There are 99 P01-P99, P00 is the broadcast address

Chapter II Meter Introduction

1.Introduction of display module

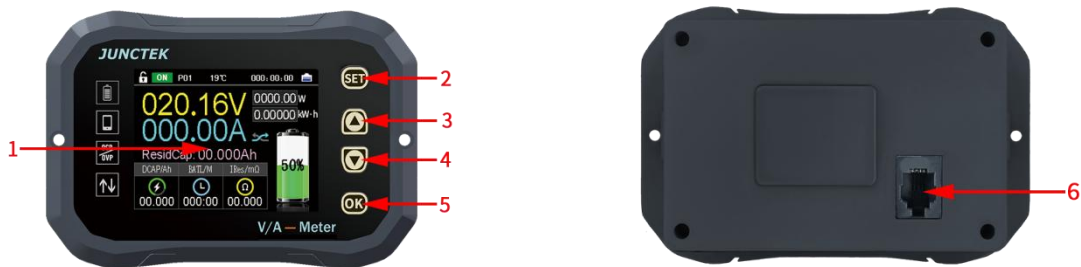

Figure 2-1-1 KG-F series display module diagram

Table 2-1-1 KG-F series display module diagram instructions

Item	Description	Item	Description
1	LCD screen	4	【▼】 button
2	【SET】 button	5	【OK】 button
3	【▲】 button	6	Wiring port

(1).LCD screen

The 2.4-inch TFT color LCD screen displays the current function menu and parameter settings.

(2). 【SET】 button

Shortly pressing the **【SET】** button can quickly switch to the setting interface.

In the main interface, press and hold the **【SET】** button can select the address and use **【▲】** **【▼】** to quickly adjust the address.

(3). **【▲】** button

When setting parameters, **【▲】** button is used to change the parameters.

When setting the system, **【▲】** button is used to select the corresponding system setting.

(4). **【▼】** button

When setting parameters, **【▼】** button is used to change the parameters.

When setting the system, **【▼】** button is used to select the corresponding system setting.

In the main interface, press and hold the **【▼】** button will jump out the “Clear data” pop-up window to confirm or cancel clear data.

(5). **【OK】** button

In the main interface, shortly pressing the **【OK】** button can control on or off of output status and data record.

Pressing and hold the **【OK】** button can quickly lock or unlock the buttons.

(6).Wiring port

The wiring port is used to connect to the measuring module.

2.Introduction of the measuring module



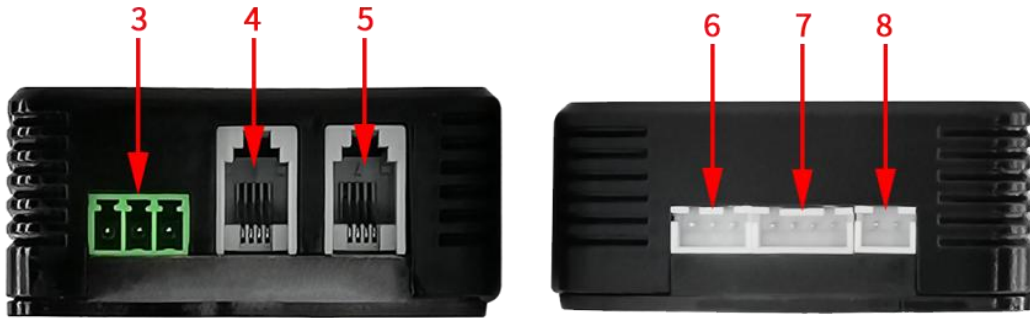

Figure 2-2-1 KG-F series measuring module diagram

Table 2-2-1 Instructions diagram of the KG-F series measuring module

Item	Description	Item	Description
1	Indicator light	5	485 communication display interface
2	2wires&3wires switch	6	Relay output control interface
3	Power supply interface	7	Sampler interface
4	485 communication connection interface	8	External temperature measurement interface

(1). Indicator light

The blinking of the indicator light indicates the working state, and the slow flashing indicates that the power supply is normal and the measurement is under normal operation.

(2). 2-wire 3-wire power supply switch selection

The switch can be selected from external power supply or self-powered, when the switch is moved up to 2W, it is suitable for self-power supply, and the voltage measurement range is 10-120V, when the switch is moved down to 3W, it is suitable for external power supply, and the external power supply voltage range is 10- 80V, the voltage measurement range is 0-120V.

(3). Power supply interface

There are three power supply interfaces, the battery positive interface: Vsns, the external power supply positive interface: VEXT, and the battery and external power supply negative interface: GND.

(4). 485 communication connection interface

The interface used to connect to the computer, and it can also be connected to another measuring module to realize multi-computer communication. The internal sequence from left to right is: B, A, GND, NC.

(5). 485 communication display interface

Used to connect with the display module, when the measuring module has power supply, the communication interface is live. The internal sequence from left to right is: B, A, GND, +5V.

(6). Relay output control interface

The relay output control interface can be used with relays. The internal sequence from left to right is: GND, OUT, VEXT.

(7). The Sampler interface

Used to connect with the sampler for current detection. The internal sequence from left to right is: VCC, GND, ISNS+, ISNS-.

(8). External temperature measurement interface

Used to connect with a temperature sensor to measure the external temperature. The internal sequence from left to right is: TSNS, GND.

3.Introduction of the Sampler

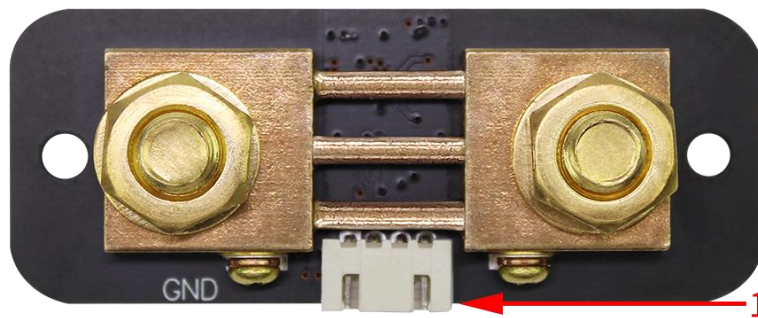

Figure 2-4-1 KG-F series of the Sampler diagram

Table 2-4-1 KG-F series of the Sampler diagram instructions

Item	Description	Item	Description
1	The Sampler interface		

The Sampler interface

Connect to the Sampler interface of the measuring module for current measurement.

4.Introduction of the display interface

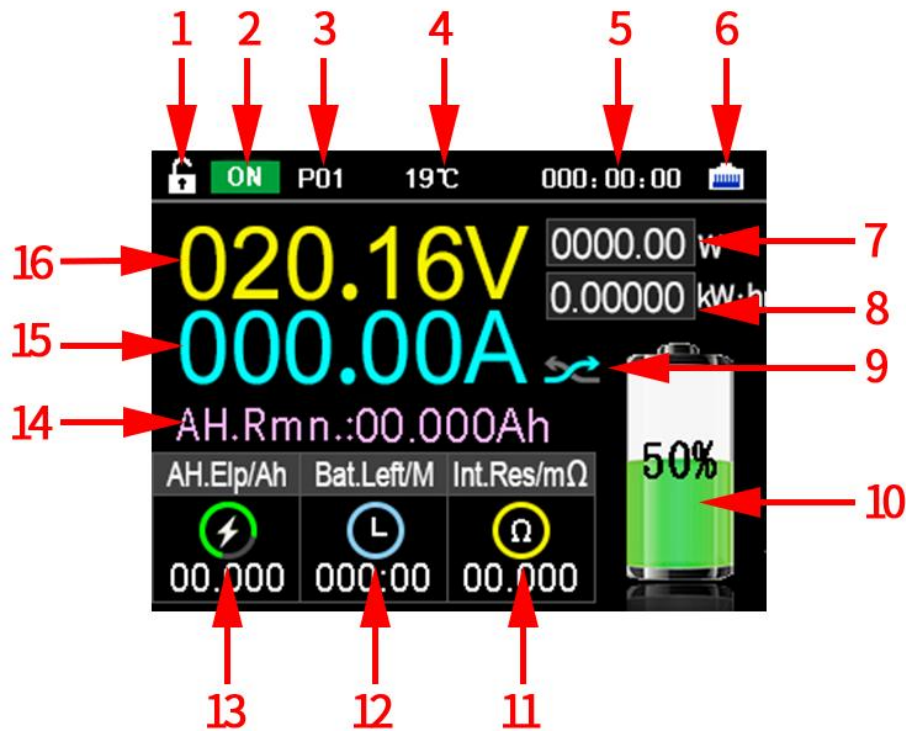



Figure 2-5-1 KG-F series display interface diagram

Table 2-5-1 KG-F series display interface diagram instructions

Item	Description	Item	Description
1	Key lock status	9	Current direction
2	Output status and data record	10	Battery remaining capacity
3	Communication address	11	Battery internal resistance
4	External temperature	12	Battery life
5	Running time	13	Elapsed AH value
6	Communication signal indication	14	Remaining AH value
7	Power	15	Measured current value
8	Elapsed electric energy	16	Measured voltage value

(1). Key lock status

The state in the figure indicates that the button can be operated. After pressing and holding the **【OK】** button,  is displayed, which means the

button is locked.

(2). Output status and data record

Shortly press the **【OK】** button to control the output status and data record on or off.

(3). Communication address

The communication address range is P00-P99. P00 is the broadcast address, used for multi-machine communication, P01 represents that the current communication address is P01, and view the data of P01 address.

(4). External temperature

It displays the ambient temperature. The current display is 19°C, which means that the temperature of the environment where the external sensor is located is 19°C.

(5). Running time

It represents the cumulative value of a single running time.

(6). Communication signal indication

The current graph means that the display module and the measuring module are connected properly. When there is a red × in the graph, it means that the communication is interrupted, and the address needs to be switched or further checked.

(7). Power

It measures the current power value, the unit is W.

(8). Elapsed electric energy

Represents the actual accumulated charging electric energy during the operation time, unit: KW. h.

(9). Current direction

It represents the direction of current passing through the Sampler. The current icon can also indicate that the battery is in a discharged state.

(10). Battery remaining capacity

The remaining capacity of the battery is highlighted more intuitively with graphics, where the 50% value means that the remaining AH. value of the battery accounts for 50% of the preset battery AH. value. In the main interface, when the remaining capacity percentage is less than or equal to 20%, the graph of remaining AH value is red, when remaining AH value percentage is greater than 20%, the graph of remaining AH value is green.

(11). Battery internal resistance (estimated)

It indicates the resistance value of the current battery internal resistance.

(12). Battery left

According to the charge and discharge current and capacity, calculate the battery left and charging time.

(13). Elapsed AH value

Indicates the cumulative discharge capacity during this operation period.

(14). Remaining AH value

Indicates the remaining capacity of the battery after charging and discharging. The remaining capacity=preset battery capacity * capacity percentage.

(15). Measured current value

It represents the actual current value through the Sampler.

(16). Measured voltage value

It represents the voltage value of the voltage measurement interface in the power supply interface.

Chapter III Basic Operation of the Meter

1. System settings

System settings Video: <https://youtu.be/oLLRZae82uU>

In the main interface, short press the **【SET】** button to enter the system setting interface. As shown in Figures 3-1-1 to 3-1-3 below.



Figure 3-1-1 System Setting 01

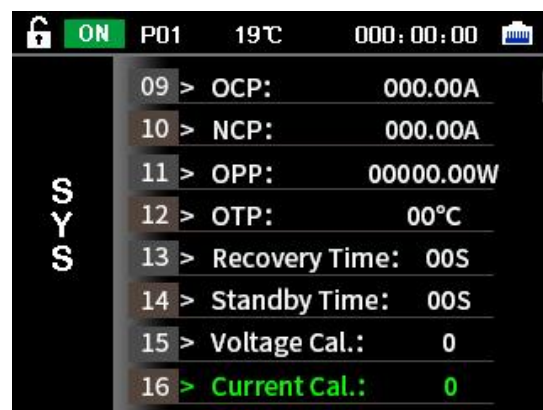

Figure 3-1-2 System Setting 02

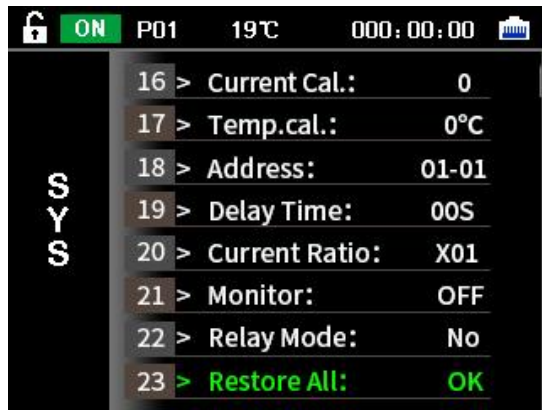

Figure 3-1-3 System Setting 03

(1). Language selection

When the “language” selection is green, you can select the language, short press the 【OK】 button, the cursor selects Chinese, press the 【▲】 【▼】 button to switch, there are two language modes, Chinese and English, then short press the 【OK】 button after confirming.

(2). Set current to zero

In the system setting interface, press the 【▲】 【▼】 button to switch to “Set current to zero”, short press the 【OK】 button and the “Set current to zero” window will pop up, and you can choose to confirm or cancel “set current to zero” by pressing the 【▲】 【▼】 buttons , When the cursor is selected to confirm, short press the 【OK】 button, if it displays “Completed” , that means setting current to zero is completed, and the current will becomes 0A.

Precautions for the first startup and / or after restoring factory settings:

When the customer starts the meter for the first time or restores the factory settings, the display will have a small current deviation under normal circumstances when the meter is not connected to the load. At this time, the charging state arrow and the discharging state arrow will jump back and forth, which means that the meter is being calibrated automatically. This phenomenon will last about 30 seconds, and then the current will return to zero automatically. At this time, we need to press the key for a long time to confirm that the current returns to zero, so that the meter can remember the zero state, and the zero current will not jump again no matter whether the machine is switched on or off or restarted.

(3). Clear accumulated data

In the system setting interface, press the 【▲】 【▼】 buttons can switch to the “Clear Data”. Short press the 【OK】 button will jump out the “Clear data” pop-up window, and then you can press 【▲】 【▼】 buttons to confirm or cancel clear data. When the cursor is selected to “OK”, short press the 【OK】 button, if it displays “Completed”, that meas the data is cleared. Time, watt-hour, and

elapsed AH value are cleared at this time, but the measuring is not affected.

(4). Preset battery AH. value

In the system setting interface, pressing the **【▲】** **【▼】** buttons can switch to the “AH. preset”. Short press the **【OK】** button, the cursor will select the value, and it can be changed by pressing the **【▲】** **【▼】** buttons. Pressing the **【OK】** button can switch the cursor position, from the smallest digit to the highest digit. At the highest position, press the **【OK】** button again to confirm and save the preset battery AH. value.

Before using the battery for the first time, you need to set the effective capacity of the battery and the current remaining power percentage correctly. If the effective capacity of the battery is unknown or the current remaining capacity is unknown, the following operation steps should be followed:

a. Empty the battery pack or put it until you don't want to discharge, at this time, the battery power is the default 0 power.

b. Enter the preset battery capacity setting in the system settings, and set the capacity value as large as possible (for example, set the estimated value 20Ah to 30Ah).

c. Set the remaining capacity percentage to 0%, and then charge the battery pack.

d. After the battery is fully charged, check the remaining capacity value displayed on the screen, and set this value to the preset battery capacity.

(5). Percentage of remaining AH value

In the system setting interface, pressing the **【▲】****【▼】** buttons can switch to the “AH. remaining”. Short press the **【OK】** button, the cursor will select the value, and it can be changed by pressing the **【▲】** **【▼】** buttons. Press the **【OK】** button again to confirm that the set remaining AH value accounts for the preset battery AH value. The remaining AH value can be set according to actual usage. And the percentage of remaining AH value is continuously adjustable from 0% to 100%.

In the main interface, when the percentage of remaining AH value is less than or equal to 20%, the graph of remaining AH value displays red, when the percentage of remaining AH value is greater than 20%, the graph of remaining AH value displays green.

After using or replacing the battery for the first time, the capacity value displayed by the coulometer is not the actual value of the battery, and capacity setting is required.

Suggestion: Set 100% for full charge and 0% for discharge, which is more accurate.

(6). Screen brightness

In the system setting interface, press the 【▲】 【▼】 buttons can switch to the “Brightness”. Short press the 【OK】 button, the cursor will select the value, and it can be changed by pressing the 【▲】 【▼】 buttons. Press the 【OK】 button again to confirm the screen brightness. The screen brightness is continuously adjustable from 1% to 100%.

(7). Under-voltage protection

In the system setting interface, press the 【▲】 【▼】 buttons can switch to the “LVP”. Short press the 【OK】 button, the cursor will select the value, and it can be changed by pressing the 【▲】 【▼】 buttons. Press the 【OK】 button can switch the cursor position, from the smallest digit to the highest digit. At the highest position, press the 【OK】 button again to confirm the set under-voltage protection value.

When the value is 000.00V, the protection function does not start, when the value is greater than 000.00V, the protection will start. If the current voltage is less than the set under-voltage protection value, the upper left of the screen will display LVP, which is in the protection state. Time stops and no more capacity is calculated.

The protection function needs to purchase the relay (If there is no relay, please do not set this value.) and install a relay in the circuit before it can play a protective role in breaking the circuit.

(8). Over-voltage protection

In the system setting interface, pressing the 【▲】 【▼】 buttons can switch to the “OVP”. Short press the 【OK】 button, the cursor will select the value, and it can be changed by pressing the 【▲】 【▼】 buttons. Pressing the 【OK】 button can switch the cursor position, from the smallest digit to the highest digit. At the highest position, press the 【OK】 button again to confirm the set over-voltage protection value.

When the value is 000.00V, the protection function does not start, when the value is greater than 000.00V, the protection will start. If the current voltage is greater than the set over-voltage protection value, the upper left of the screen will display OVP, which is in the protection state. Time stops and no more capacity is calculated.

The protection function needs to purchase the relay (If there is no relay, please do not set this value.) and install a relay in the circuit before it can play a protective role in breaking the circuit.

(9). Positive over-current protection

In the system setting interface, pressing the 【▲】 【▼】 button to switch to the discharge over current protection setting. Short press the 【OK】 button, the cursor will select the value, and it can be changed by pressing the 【▲】 【▼】 buttons. Pressing the 【OK】 button can switch the cursor position, from

the smallest digit to the highest digit, at the highest position, press the **【OK】** button again to confirm the discharge over current protection.

When the value is 000.00V, the protection function does not start, when the value is greater than 000.00V, the protection will start. If the current discharge current is greater than the set discharge over-current protection value, OCP will be displayed on the upper left of the screen, which is in the protection state. Time stops and no more capacity is calculated.

The protection function needs to purchase the relay (If there is no relay, please do not set this value.) and install a relay in the circuit before it can play a protective role in breaking the circuit.

(10). Negative over-current protection

In the system setting interface, press the **【▲】【▼】** key to switch to the setting of discharge over-current protection. After briefly pressing the **【OK】** key, the cursor selects the value, and it can be changed by pressing the **【▲】【▼】** buttons. Pressing the **【OK】** button can switch the cursor position, from the smallest digit to the highest digit, at the highest position, press the **【OK】** button again to confirm the set charge over-current protection.

When the value is 000.00A, the protection function will not be started. If the value is greater than 000.00A, the protection function will be started. If the charging current is greater than the set charging over-current protection value, NCP will be displayed at the top left of the screen, which is in the protection state. Time stops and no more capacity is calculated.

The protection function needs to purchase the relay (If there is no relay, please do not set this value.) and install a relay in the circuit before it can play a protective role in breaking the circuit.

(11). Over power protection

In the system setting interface, pressing the **【▲】【▼】** buttons can switch to the "OPP". Short press the **【OK】** button, the cursor will select the value, and it can be changed by pressing the **【▲】【▼】** buttons. Pressing the **【OK】** button can switch the cursor position from the smallest digit to the highest digit. At the highest position, press the **【OK】** button again to confirm the set over power protection value.

When the value is 00000.00W, the protection function does not start, when the value is greater than 00000.00W, the protection will start. If the current power is greater than the set over power protection value, the upper left of the screen will display OPP, which is in the protection state. Time stops and no more capacity is calculated.

The protection function needs to purchase the relay (If there is no relay, please do not set this value.) and install a relay in the circuit before it can play a protective role in breaking the circuit.

(12). Over temperature protection

In the system setting interface, pressing the 【▲】【▼】 buttons can switch to the “OTP”. Short press the 【OK】 button, the cursor will select the value, and it can be changed by pressing the 【▲】 【▼】 buttons. Press the 【OK】 button again to confirm the set over temperature protection.

When the value is 00°C, the protection function does not start, when the value is greater than 00°C, the protection will start. If the current ambient temperature exceeds the set over-temperature protection value, the upper left of the screen will display OTP, which is in the protection state. Time stops and no more capacity is calculated.

The protection function needs to purchase the relay (If there is no relay, please do not set this value.) and install a relay in the circuit before it can play a protective role in breaking the circuit.

(13). Reverting time protection

In the system setting interface, pressing the 【▲】【▼】 buttons can switch to the “Revert time”. Short press the 【OK】 button, the cursor will select the value, and it can be changed by pressing the 【▲】 【▼】 buttons. Press the 【OK】 button again to confirm the reverting time protection.

When the value is 00s, the protection status will continue until the 【OK】 button is pressed in the main interface to implement the protection status. If the value is greater than 00s, for example, the protection recovery time is set to 5s, which means 5 seconds after the value returns to the normal value, the protection state is automatically canceled, the circuit is closed and work begins.

(14). Enter standby time

In the system setting interface, pressing the 【▲】【▼】 buttons can switch to the “Standby Time”. Short press the 【OK】 button, the cursor will select the value, and it can be changed by pressing the 【▲】 【▼】 buttons. Press the 【OK】 button again to confirm the set standby time.

0 is changed to normally on, 1-60s indicates how long the screen will be off without operation (no matter whether there is current or not, the screen will be off, press any key to wake up the screen); It automatically indicates that the current is 0 and lasts for 20 seconds, and the screen turns off. Once there is current, the screen turns on immediately.

(15). Voltage calibration

In the system setting interface, press the 【▲】 【▼】 buttons can switch to the “Voltage Cal.”. Short press the 【OK】 button, the cursor will select the value and it can be changed by pressing the 【▲】 【▼】 buttons. Press the 【OK】 button again to confirm the set voltage calibration. The voltage fine-tuning calibration can be performed online. The default voltage calibration is 0, and the maximum voltage calibration range is $\pm 10\%$.

(16). Current calibration

In the system setting interface, pressing the **【▲】【▼】** buttons can switch to the “Current Cal.”. Short press the **【OK】** button, the cursor will select the value and it can be changed by pressing the **【▲】 【▼】** buttons. Press the **【OK】** button again to confirm the set current calibration. The current fine-tuning calibration can be performed online. The default current calibration is 0, and the maximum current calibration range is $\pm 25\%$.

(17). Temperature calibration

In the system setting interface, pressing the **【▲】【▼】** buttons can switch to the “Temp. Cal.”. Short press the **【OK】** button, the cursor will select the value and it can be changed by pressing the **【▲】 【▼】** buttons. Press the **【OK】** button again to confirm the set temperature calibration. The temperature fine-tuning calibration can be performed online. The default temperature calibration is 0°C.

(18). Set address

In the system setting interface, press the **【▲】 【▼】** button to switch to the address setting, short press the **【OK】** button and select the value with the cursor, press the **【▲】 【▼】** button to change the communication address, Press the **【OK】** button to switch from the preset communication address to the current communication address, and press the **【OK】** button again to confirm the set address.

Example: As shown in Figure 3-1-3, the set address is 03-01, 01 represents the preset communication address, the preset communication address range is 01-99, 03 represents the current measuring module communication address, and the current communication address range is 00-99 , 00 represents the broadcast address. If we don't know the current communication address of the measuring module, we can set the current communication address to 00, and set the default communication address to the desired address 03 (for example: 00-03). After setting, press **【OK】** to complete the setting. At this time, the current communication address of the measuring module is 03, and the meter can communicate normally. (Use the broadcast address with caution in multi-machine communication)

When multiple measuring modules are connected, the current communication address can be switched to control the measuring module corresponding to the address. At 00, multiple measuring modules can be controlled at the same time.

(19). Set delay time

In the system setting interface, pressing the **【▲】【▼】** buttons can switch to the “Delay Time”. Short press the **【OK】** button, the cursor will select the value and it can be changed by pressing the **【▲】 【▼】** buttons. Press the **【OK】** button again to confirm the set delay time.

When the delay time is set to 00s and the measured value exceeds the set protection value, the meter will immediately enter the protection state, when the delay time is greater than 00s, for example, it is set to 5s, when the measured value exceeds the set protection value, the meter enters the protection state after 5s.

(20). Current ratio (this function is only available for KG-H series Hall sensor version)

In the system setting interface, press the **【▲】** **【▼】** button to switch to the current ratio setting, short press the **【OK】** button and the cursor selects the value, press the **【▲】** **【▼】** button to change the value, and then press the **【OK】** button again to confirm the set current ratio. The default is X01.

Example: When the wire of the Hall sensor is wound 10 times, the current multiplier is set to X01, the measured current value is displayed as the total current passing through the Hall sensor 10 times, the current multiplier is set to X10, and the measured current value is displayed as passing The current value of one turn of the Hall sensor wire. Can be used to measure small currents.

(21). Monitor function

In the system setting interface, pressing the **【▲】****【▼】** buttons can switch to the "Monitor function". Short press the **【OK】** button and then press the **【▲】** **【▼】** buttons to switch on or off. The monitor function must be turned on when using the computer software control. After the monitor function is turned on, the setting function in the display module can only set the system language, working screen brightness and enter the standby time (After the monitoring function is turned on, the display module will not automatically update the data.).

(22).Relay mode

In the system setting interface, pressing the **【▲】****【▼】** buttons can switch to the "Relay Mode". Short press the **【OK】** button and then press the **【▲】** **【▼】** buttons to switch between "NO" and "NC".

After the selection is completed, press the **【OK】** button again to confirm the type of relay. When using this function, you need to select normally open or normally closed according to the relay type connected during actual wiring.

(23). Restore factory settings

In the system setting interface, press the **【▲】** **【▼】** key to switch to restore the factory settings. After a short press of the **【OK】** key, the restore factory settings box will pop up. Through the **【▲】** **【▼】** key, you can select to confirm or cancel the restore factory settings. When the cursor is selected to confirm, press the **【OK】** key briefly. if the display shows success, the restore factory settings will be completed.

2. Wiring method

Wiring instructions video: <https://youtu.be/Hjj9fkyuNp0>

(1). Self-powered wiring method

If the voltage range of the tested battery is between 10-120V during normal operation, self-powered wiring can be used. First, turn the power supply selection interface switch to "2W", and then connect the positive terminal of the battery to the power supply interface "Vsns", This line does not need to be particularly thick, 13-16AWG wire is fine. Pay attention to the positive and negative poles of the battery, do not connect the wrong or reverse connection.

The negative pole of the battery is connected to the screw with the battery "BATT-" on the sampler, and the negative pole of the charger and the negative pole of the load are connected to another screw of the sampler. It is better to use a copper nose to connect it firmly. When charging, the current direction symbol color is red, and the remaining capacity value increases. When discharging, the color of the current direction symbol is sky blue, and the remaining capacity value decreases.

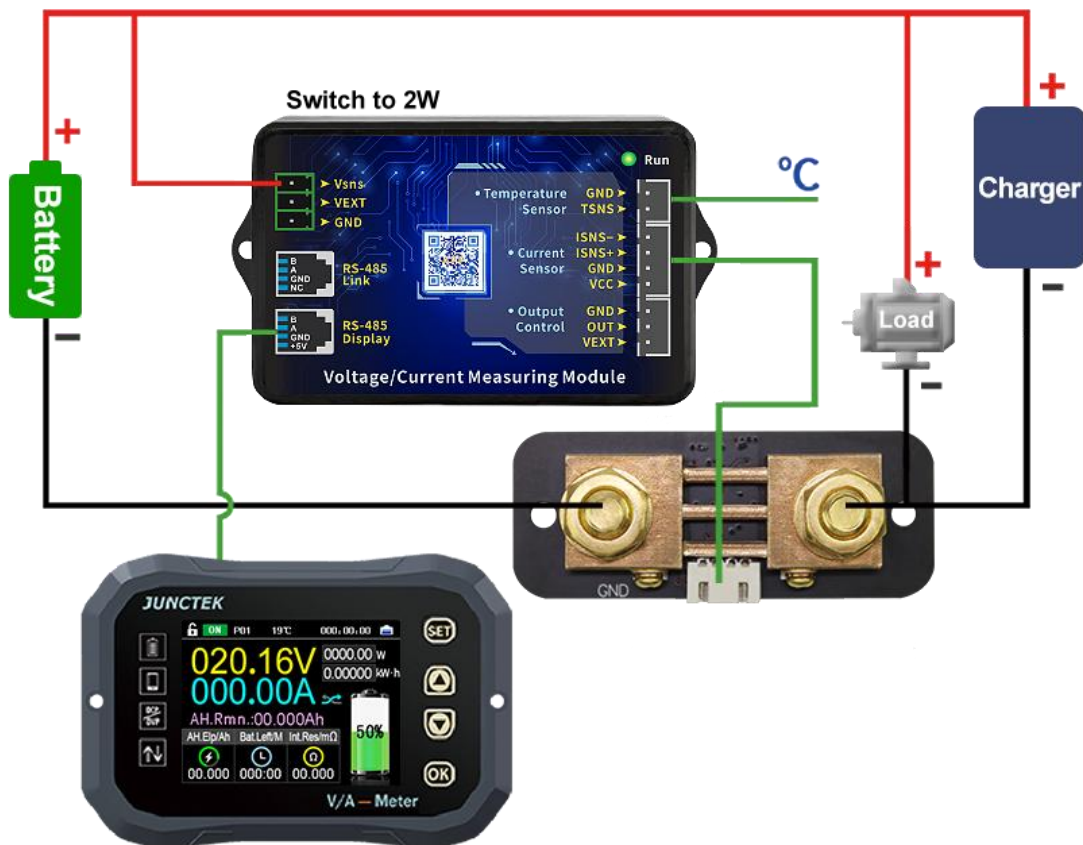

Figure 3-3-1 Self-powered wiring diagram

(2). External power supply wiring method

The measuring voltage range of the external power supply is 0-120V. First, set the power selection interface switch to "3W", connect the positive pole of the external power supply to the power interface "VEXT", and connect the negative pole of the external power supply to "GND". When wiring, connect the positive pole of the battery to the measurement interface "Vsns" in the power interface. Note that the positive and negative poles of the battery and the external power supply should not be connected incorrectly or reversed.

The negative pole of the battery is connected to the screw with the battery "BATT-" on the sampler, and the negative pole of the charger and the negative pole of the load are connected to the other screw of the sampler together. It is better to use copper nose to connect firmly. When charging, the current color is green and the residual capacity value increases. When discharging, the current color is sky blue and the residual capacity value decreases.

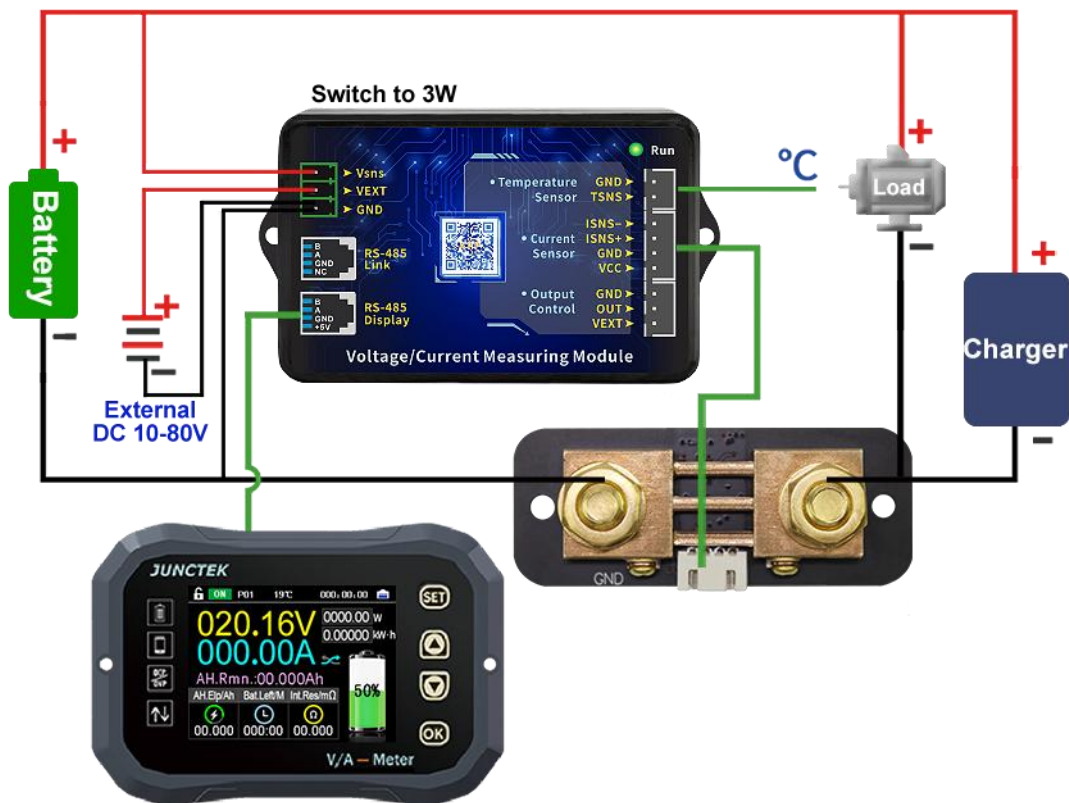

Figure 3-3-2 External power supply wiring diagram

(3). External power supply wiring method (Relay control)

The working power of the relay is provided by an external power supply. If the relay is connected, an external power supply with the same working voltage as the relay should be provided. Connect the control ports of the relay to the "OUT" and "VEXT" of the measurement module Output Control, connect the positive pole of the external power supply to the "VEXT" of the Output Control, and the negative pole of the external power supply to the "GND". Note

that the positive and negative poles of the battery and the external power supply should not be connected wrongly or reversed.

If you want to control the charging or discharging, you should connect the wiring according to the wiring diagram of external power supply relay in figure 3-3-3. When the relay is closed, the indicator light will be on, and when it is disconnected, it will be off as a prompt.

The negative pole of the battery is connected to the screw with the battery "BATT-" on the sampler. The negative pole of the charger and the negative pole of the load are connected to the other screw of the sampler. It is better to use a copper nose to connect it firmly. When charging, the current direction symbol color is red, the remaining capacity value increases. When discharging, the current direction symbol color is sky blue, and the remaining capacity value decreases.

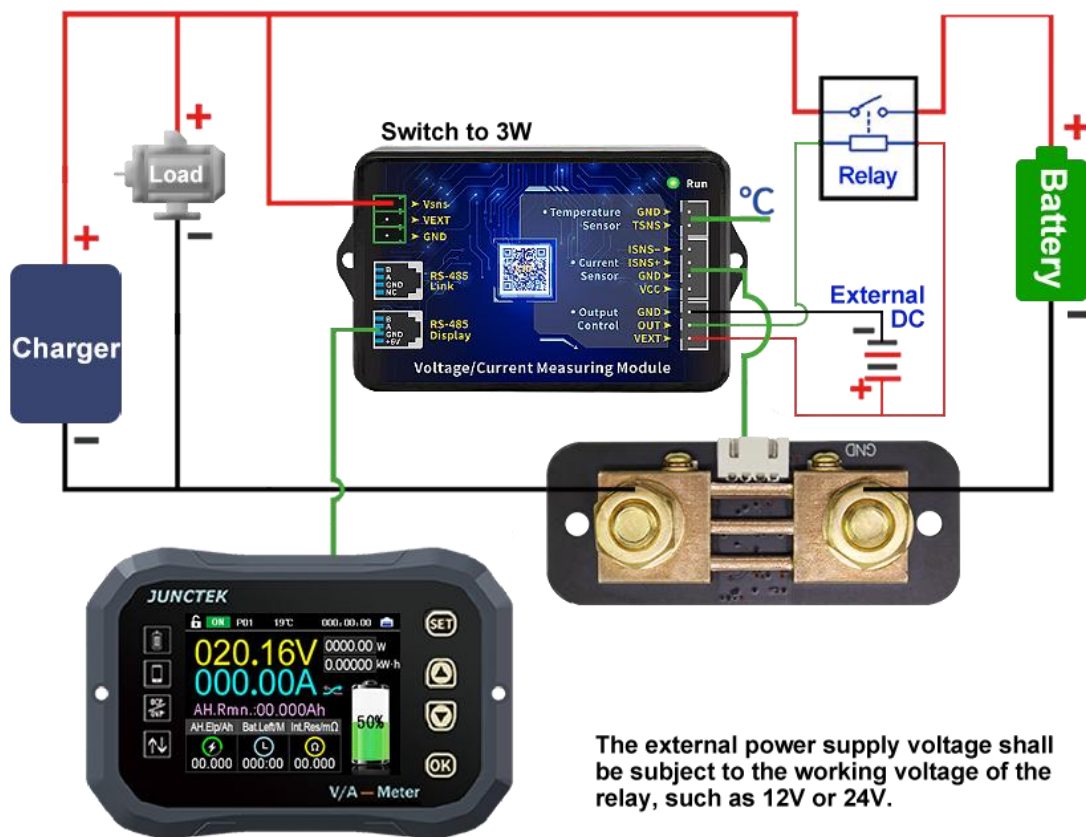

Figure 3-3-3 External power supply wiring diagram (Relay control)

3.Communication protocol control

We only provide communication protocol, customers can carry out secondary development according to communication protocol.

1.Overview

The command line is used as the control command, and the communication rate is 115200. The PC sends out the command, the meter

parses and executes it, and then returns the result to the PC. The different commands are described below.

The sending data format is as follows :

Start bit	Function code	Function No.	Connector	Address symbol	Spacer
:	W,R	00~99	=	1-99	,
Checksums	Spacer	Data field	Spacer	Terminator	
1-255	,	See instructions	,	<CR><LF>	

Explain:

- (1) Function code: "W" is the write instruction used to set various parameters, and "R" is the parameter used by the read instruction to return to the machine.
- (2) Function No.: different values represent different parameter settings.
- (3) Address symbol: address range is 1-99, 0 is broadcast address.
- (4) Checksum: the value of the sum is obtained by adding 1 to the remainder of 255 after the sum of all the numbers after the check sum. If the sum of the check is taken as 0, it means that it is not verified.
- (5) Data field: the data field is equivalent to the number of operations of the command. For example: W20=12162000, the instruction operands are 2000, which means that the over voltage protection is set to 20.00V.
- (6) Terminator: Each instruction ends with a carriage return + line feed, and <CR> represents the carriage return in the ASCII character table (hexadecimal representation is 0x0d). <LF> is the newline character in the ASCII character table (in hexadecimal notation is 0x0a). The above two methods indicate carriage return and line feed.

1. W instructions

Function code	Set up	Send command	Illustrate
01	Set address	:W01=1,3,2,	The communication address is set to 2 (this command should be used with caution, if you want to use it, you must know the current communication address and the communication address to be set, it is recommended to use the mobile APP to modify)
10	Turn on the output	:W10=1,2,1, :W10=1,0,0,	Turn on output status and data recording Turn off output status and data recording
20	Set	:W20=1,216,2000,	The over-voltage protection value is

	over-voltage protection		set to 20.00V.
21	Set under-voltage protection	:W21=1,216,2000,	The under-voltage protection value is set to 20.00V.
22	Set positive over-current protection	:W22=1,216,2000,	The positive over-current protection value is set to 20A.
23	Set negative over-current protection	:W23=1,216,2000,	The negative over-current protection value is set to 20A.
24	Set over power protection	:W24=1,216,2000,	The over power protection value is set to 20W.
25	Set over temperature protection	:W25=1,151,150, :W25=1,211,210,	The over temperature protection value is set at 50 °C. The over temperature protection value is set to 110 °C.
26	Set protection reverting time	:W26=1,31,30,	The protection reverting time is set to 30s.
27	Set delay time	:W27=1,31,30,	The delay time is set to 30s.
28	Set battery capacity	:W28=1,216,2000,	The battery capacity is set at 200.0Ah.
29	Voltage calibration settings	:W29=1,121,120, :W29=1,81,80,	Set the voltage calibration value to 20, and fine-tune to increase the voltage value. Set the voltage calibration to a value of -20, and fine-tune to reduce the voltage value. (The value only represents the fine-tuning factor, the greater the absolute value of the value, the greater the amplitude of the fine-tuning)
30	Current calibration settings	:W30=1,121,120, :W30=1,81,80,	Set the current calibration value to 20, and fine-tune to increase the current value. Set the current calibration to a value of -20, and fine-tune to reduce the current value. (The value only represents the fine-tuning factor, the greater the absolute value of the value, the greater the amplitude of the fine-tuning)

31	Temperature calibration settings	:W31=1,104,103, :W31=1,99,98,	Set the temperature calibration value to 3°C, and the temperature increases by 3°C. Set the temperature calibration value to -2°C, and the temperature decreases by 2°C.
33	Reserved settings (coming soon)	Reserved settings (coming soon)	Reserved settings (coming soon)
34	Set relay type	:W34=1,2,1, :W34=1,0,0,	Set the relay type to normally closed. Set the relay type to normally open.
35	Restore factory settings	:W35=1,2,1,	Perform factory reset
36	Set current ratio	:W36=1,4,3,	The current ratio is set to 3.
37	Setting voltage curve scale	:W37=1,4,3,	The voltage curve scale is set to 03v / Div.
38	Setting current curve scale	:W38=1,4,3,	The current curve scale is set to 03v / Div.
60	Set the percentage of battery remaining capacity	:W60=1,51,50,	50% of battery capacity remaining
61	Current clear to zero	:W61=1,2,1,	Perform current clear to zero
62	Clear accumulated data	:W62=1,2,1,	Perform clear accumulated data

2. R instructions

The R command is a read command, and its command format is basically the same as the write command format. The description will not be repeated here. The following is the data returned by the machine, which is just an example.

Read	PC sending	Machine return	Read instructions
Read basic machine inform	:R00=1,2,1,	:r00=1,47,1120,100,101,	1 represents the communication address; 47 stands for check sum; In 1120, the first one represents Hall sensor (1-hall sensor, 2-shunt

ation			sampler), the second one represents 100V, and 20 represents 200A; 100 represents version 1.00; 101 represents the machine serial number;
Read all measured values	:R50=2,2,1,	:r50=2,215,2056,200,5408,4592,9437,14353,134,0,0,0,162,30682,	2 represents the communication address; 215 represents the checksum; 2056 represents the voltage of 20.56V; 200 represents current 2.00A; 5408 represents the remaining battery capacity is 5.408Ah; 4593 means the cumulative capacity is 4.593Ah; 9437 represents the watt-hour is 0.09437kw.h; 14353 represents the running time of 14353s; 134 represents the ambient temperature is 34°C; 0 means the function is pending; 0 means the output status is ON; (0-ON, 1-OVP, 2-OCP, 3-LVP, 4-NCP, 5-OPP, 6-OTP, 255-OFF) 0 represents the direction of current, and the current is forward current; (0-forward, 1-reverse) 162 means battery life is 162 minutes; 30682 represents the internal resistance of the battery is 306.82mΩ.
Read all settings	:R51=1,2,1,	:r51=1,211,3000,100,2000,2000,10000,151,10,7,200,120,90,101,0,0,2,12,13,	1 represents the communication address; 211 stands for checksum; 3000 means that the over-voltage protection is 30.00V; 100 means that the under-voltage protection is 1.00V; 2000 means that the positive over-current protection is 20.00A; 2000 represents the negative over-current protection is -20.00A;

			<p>10000 means that the over power protection is 100.00W; 151 means that the over-temperature protection is 51°C; 10 means the protection recovery time is 10s; 7 means the delay time is set to 7s; 200 means that the preset battery capacity is 20.0Ah; 120 represents the value of the voltage calibration is 20, and the voltage fine-tuning increases; (100 means no fine-tuning) 90 represents the value of the current calibration is 10, and the current fine-tuning is reduced; (100 means no fine-tuning) 101 represents a temperature calibration increase of 1°C; (100 means no fine-tuning) 0 stands for reserved settings (coming soon); 0 represents the relay type is normally open; (0-normally open relay, 1-normally closed relay) 2 represents the current ratio is 2; 12 represents the voltage curve scale is 12V/div; 13 represents the current curve scale is 13A/div.</p>
--	--	--	---

4.Mobile APP control

1. App Instructions (For Android)

Android mobile app installation and operation demonstration video:

<https://youtu.be/IFtG6Li8yfk>

(1) App download

Google download link:

<https://play.google.com/store/apps/details?id=com.juntek.vat>

Server download link:

<http://68.168.132.244/app/KG.apk>

(If you cannot download, you can ask customer service to obtain the software.)

(2) App Software Installation

This software only supports Android 5.0 and more advanced systems. It will apply for location during the installation. Please agree and turn on location services. The Bluetooth module cannot be plugged or unplugged in a powered state, which may cause damage. This guide corresponds to software version 1.4.26, and different versions may be slightly different. It is recommended to upgrade to the latest version for a better experience. The installation steps are shown in figure 3-5-1 to 3-5-3 below.

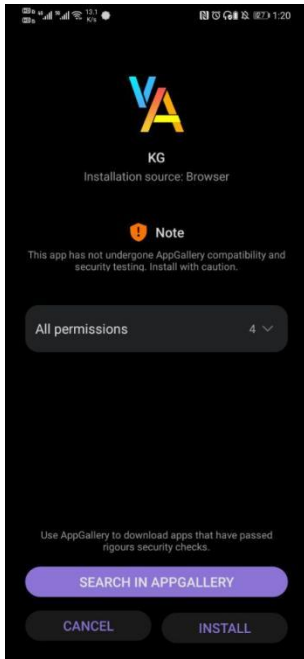

Figure 3-5-1
Installation step 1

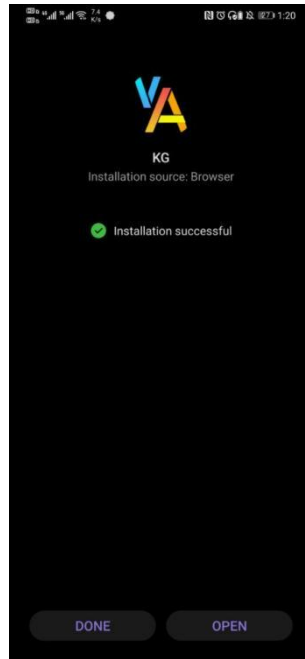

Figure 3-5-2
Installation step 2



Figure 3-5-3
Installation step 3

(3) Software update

Click the App icon, after the App is started, the system will automatically detect whether there is a new version of the App in the background, and the new version will pop up to remind you to update. Apps downloaded from Google play need to manually detect new versions.

(4) App interface



Figure 3-5-4 Main interface



Figure 3-5-5 Curve

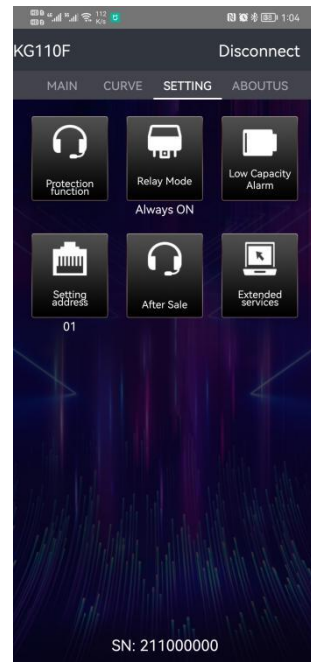

Figure 3-5-6 System Settings

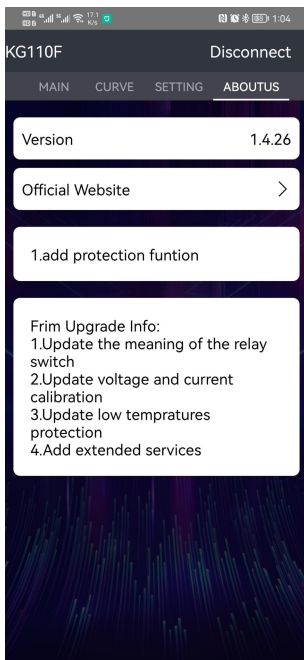

Figure 3-5-7 About us

(5) App operation instructions

➤ Connection

Open the APP on the homepage and click the **【Search】** in the upper right corner to search for the corresponding Bluetooth. After clicking the corresponding Bluetooth, the interface will pop up "Connected", and the **【Search】** in the upper right becomes disconnected, and the meter model appears, indicating that the connection is complete. As shown in Figure 3-5-8,

Figure 3-5-9, Figure 3-5-10.



Figure 3-5-8 Connect 1



Figure 3-5-9 Connect 2



Figure 3-5-10 Connect 3

➤ Main interface operation

Output state control switch: Click to control the output state, and different states will be displayed under different protection states, as shown in Figure 3-5-11 and 3-5-12.

Voltage calibration: Click on the voltage value, "input voltage calibration" will pop up, enter the corresponding value for fine-tuning, as shown in Figure 3-5-13 below.

Current calibration: Click on the current value, "input current calibration" will pop up, enter the corresponding value for fine-tuning, as shown in Figure 3-5-14 below.

Voltage range: Click on the voltage dial, the pop-up box "Input voltage range" will pop out, enter the corresponding value, you can adjust the scale range of the voltage dial, as shown in Figure 3-5-15 Voltage scale range.

Current scale maximum value: Click on the current scale dial, the pop-up box "Input the maximum current value" pops out, enter the correct value to adjust the maximum scale value of the current dial, as shown in Figure 3-5-16 Current scale maximum value.

Zero current: When the load is 0, click the zero current button, the pop-up box "Zero current" pops out, click OK to memorize the current in this state, as shown in Figure 3-5-17 Zero current.

Clear data: Click the clear data button, the pop-up box "Clear cumulative data " will pop up, click OK to reset the time, watt-hour, and cumulative capacity, as shown in Figure 3-5-18 Clear data.

Remaining capacity percentage: Click the battery icon, the pop-up box "Input percentage of remaining capacity" will pop up, enter the corresponding value and click OK to complete the modification, as shown in Figure 3-5-19 Remaining capacity percentage.

Preset battery capacity: Click the setting button to the right of the preset battery capacity, the pop-up box "Input preset battery AH value" will pop up, enter the corresponding value and click OK to complete the modification, as shown in Figure 3-5-20 Preset battery capacity.

Ambient temperature: Click the ambient temperature icon to pop up the pop-up box and enter "external temperature calibration", enter the correct value and click OK to complete the modification, as shown in Figure 3-5-21 ambient temperature.

Ambient temperature unit switching: Click the ambient temperature value to pop up the pop-up "Temperature Unit", select Celsius or Fahrenheit, the default is Celsius. As shown in Figure 3-5-22 temperature unit.



Figure 3-5-11
Output status :Off



Figure 3-5-12
Over-voltage protection
status

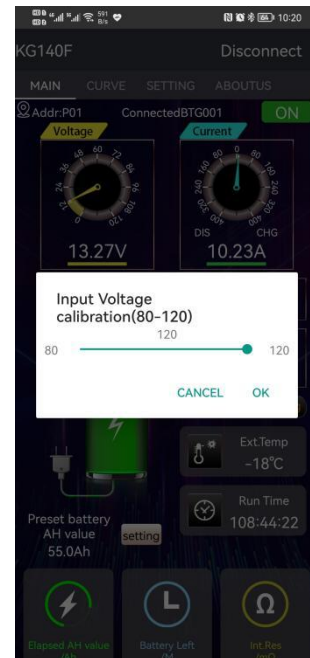

Figure 3-5-13
Input Voltage calibration



Figure 3-5-14
Input Current calibration

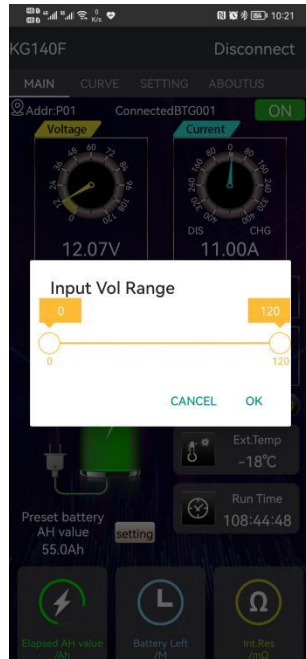

Figure 3-5-15
Voltage Range



Figure 3-5-16
Input Max Current

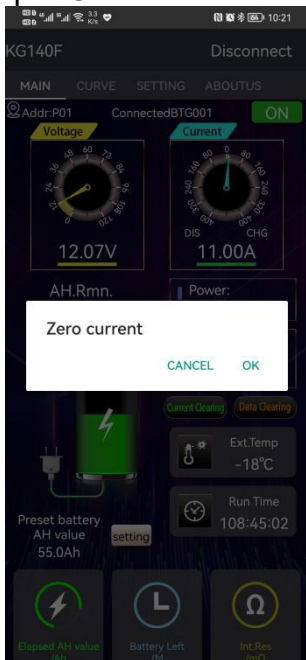

Figure 3-5-17
Zero current

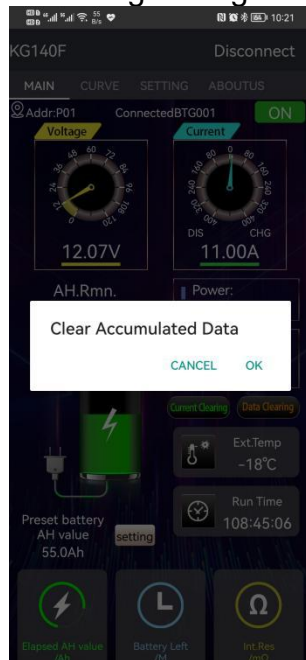

Figure 3-5-18
Clear Accumulated
Data

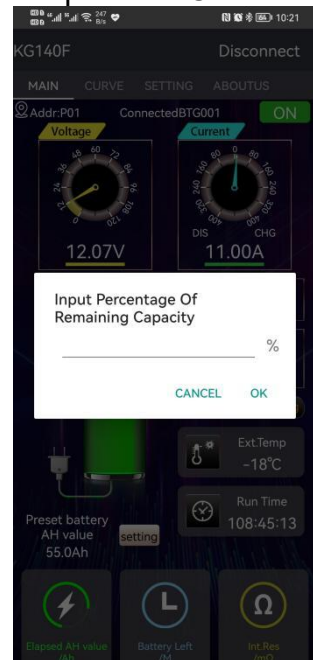

Figure 3-5-19
Remaining Capacity
Percentage

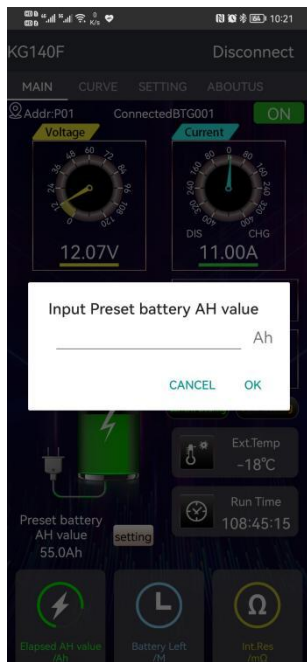

Figure 3-5-20
Input Preset battery AH
value

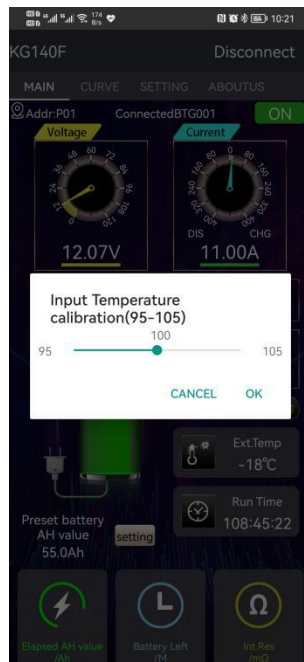

Figure 3-5-21
Input Temperature
calibration

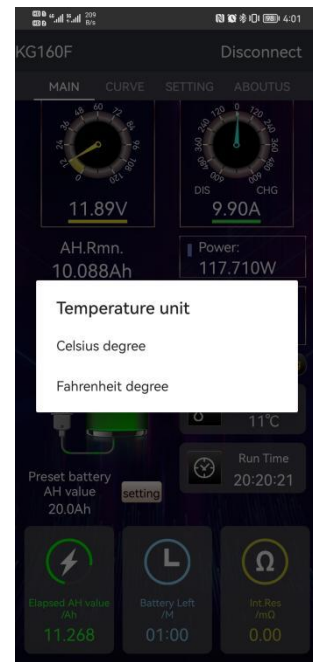

Figure 3-5-22
Temperature unit

➤ Curve interface operation

Voltage and current real-time curve: When the green circle icon appears before the text of the voltage and current real-time curve, and the text turns green, it means that the voltage and current real-time curve is selected, click the value displayed by the voltage and current, and the voltage or current real-time curve can be displayed separately. And the opening and closing of the voltage and current real-time curve is associated with the output state and the data recording switch of the main interface. Only when the output state and the data recording switch are turned on (ON), the voltage and current real-time curve recording will be turned on. The real-time curve of voltage and current is shown in Figure 3-5-23 below.

Voltage and current history curve: Click the "History: OFF" button to turn on the voltage and current history curve. At this time, a green circular icon appears before the text of the voltage and current history curve, and the text turns green, and the button changes to "History: ON"; click The value displayed by voltage and current can display the voltage or current history curve separately; in the voltage and current history curve graph, you can slide left and right to view the voltage and current curve in the historical time, as shown in Figure 3-5-24 Voltage and current history curve .

Export curve: When viewing the voltage and current history curve, the export curve button will appear. After clicking it, an EXECL file will be generated, and the voltage and current values of the history curve can be viewed at a specific time, as shown in Figure 3-5-25.

Custom export curve: When viewing the voltage and current history curve, the export curve button will appear. After clicking, select the time range of the export curve. After the export is confirmed, the export progress will be displayed on the screen. The completion of the progress bar indicates the success of the export curve data. Note: Do not close the KG application during the process of exporting the curve. The maximum time range for exporting is 12 hours, and the longer the exporting time is, the longer the exporting time will be. When exporting curve data, please wait patiently. The following figure 3-5-26 is the export curve, As shown in the figure below, 3-5-27 is the export curve progress bar.

Custom viewing curve: When viewing the voltage and current history curve, the View Curve button will appear. After clicking, select the time range for viewing the curve. After confirming the viewing, the export progress will be displayed on the screen. After the progress bar is finished, it will enter the horizontal screen interface. You can view the voltage and current trends during this period of time, click on the curve, you can easily view the voltage and current values at that point in time. Note: Do not close the KG application while viewing the curve. The maximum time range you can select to view is 12 hours, and the longer you select to view, the longer you can view the curve. Please be patient when entering to view the curve. As shown in the figure below, 2-5-28 is the export curve, and the figure 2-5-29 is the progress bar of the export curve.

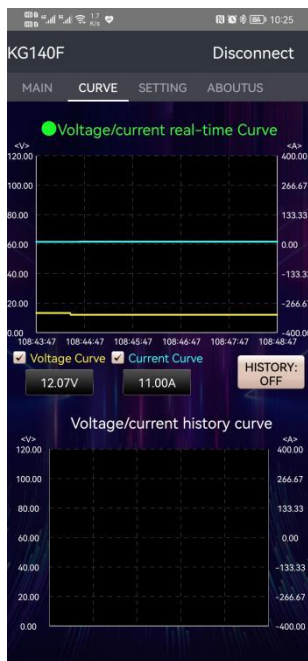

Figure 3-5-23
Voltage/current
real-time curve



Figure 3-5-24
Voltage/current history
curve

Time	Voltage	Current
00:00:01	31.34V	0.00A
00:00:02	31.34V	0.00A
00:00:03	31.34V	0.00A
00:00:04	31.34V	0.00A
00:00:05	31.34V	0.00A
00:00:06	31.34V	0.00A
00:00:07	31.34V	0.00A
00:00:08	31.34V	0.00A
00:00:09	31.34V	0.00A
00:00:10	31.34V	0.00A
00:00:11	31.34V	0.00A
00:00:12	31.34V	0.00A
00:00:13	31.34V	0.00A
00:00:14	31.34V	0.00A
00:00:15	31.34V	0.00A
00:00:16	31.34V	0.00A
00:00:17	31.34V	0.00A
00:00:18	31.34V	0.00A
00:00:19	31.34V	0.00A
00:00:20	31.34V	0.00A
00:00:21	31.34V	0.00A
00:00:22	31.34V	0.00A
00:00:23	31.34V	0.00A
00:00:24	31.34V	0.00A

Figure 3-5-25
Export curves

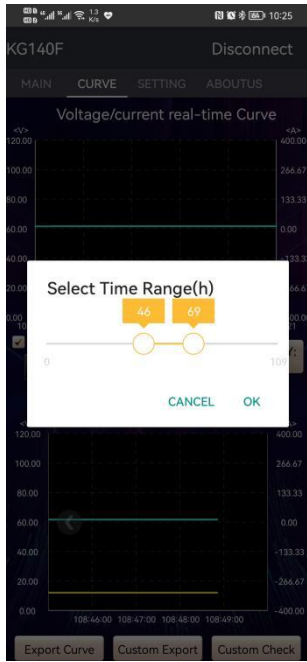

Figure 3-5-26
Export curve



Figure 3-5-27
Export curve progress bar

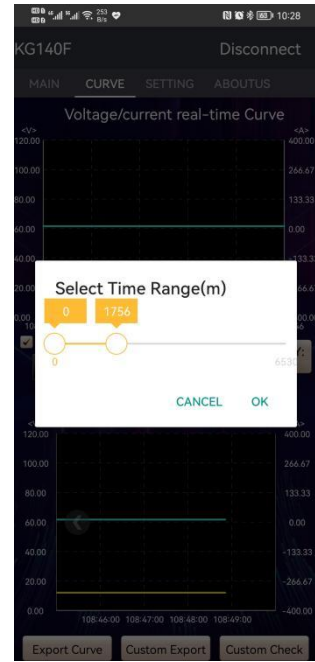

Figure 3-5-28 Select
Time Range



Figure 3-5-29 view curve

➤ System setting interface operation

Protection function: Click the protection function button to enter the protection function interface. The protection function needs to be installed with a relay. If no relay is installed, please adjust the protection setting parameters to 0. The default 0 is to close the protection function. As shown in Figure 3-5-30 below.

Over-voltage protection: Click the OVP button to jump out the “Input over-voltage protection” pop-up window, enter the corresponding value and click OK to complete the modification, as shown in Figure 3-5-31 below.

Under-voltage protection: Click the LVP button to jump out the “Input under-voltage protection” pop-up window, enter the corresponding value and click OK to complete the modification, as shown in Figure 3-5-32 below.

Input Positive Over-current Protection: Click the OCP discharge over current

protection button, and the “Input positive over current protection” pop-up box will pop up, enter the corresponding value and click OK to complete the modification, as shown in Figure 3-5-33 below.

Over-temperature protection: Click the OTP over temperature protection button, the “Input external over temperature protection” pop-up box will pop up, enter the corresponding value and click OK to complete the modification, as shown in Figure 3-5-34 below.

Over power protection: Click the OPP over-power protection button, the “Input over power protection” pop-up box will pop up, enter the corresponding value and click OK to complete the modification, as shown in Figure 3-5-35 below.

Input Negative Over-current Protection: Click the NCP charging over-current protection button, the “Input negative over current protection” pop-up box will pop up, enter the corresponding value, click OK to complete the modification, as shown in Figure 3-5-36 below.

Low temperature protection: Click the low temperature protection to pop up the "low temperature protection pop-up" pop-up box, you can choose to turn on or off the low temperature protection, click to open to pop up the pop-up box "input low temperature protection (-20-20) °C", enter the corresponding value and click OK to complete the modification. The low temperature protection function is not activated by default. When we set the low temperature protection value to 0°C, if the value is less than 0°C, the protection will be activated. The upper right corner of the APP main interface will display LTP, which is in the protection state. As shown in Figure 3-5-37 and Figure 3-5-38 below.

Protection recovery time: Click the protection recovery time button to pop out the "Enter protection recovery time" pop-up box, enter the corresponding value and click OK to complete the modification, as shown in Figure 3-5-39 below.

Delay time: Click the delay time button to pop out the "Input delay time" pop-up box, enter the corresponding value and click OK to complete the modification, as shown in Figure 3-5-40 below.

Relay type: Click the relay type button to pop out the "Relay type normally open and normally closed option" pop-up box, select the relay type relative to the actual, as shown in Figure 3-5-41 below.

Low-capacity reminder: Click the low-capacity reminder to pop up the pop-up box "Enter low-capacity reminder", enter the corresponding capacity percentage and click OK to complete the modification. When the KG-F mobile

APP is connected to the instrument's Bluetooth, of course, the battery capacity percentage is lower than the set value. , a low capacity reminder will be displayed in the status bar of the mobile phone, as shown in Figure 3-5-42 below.

Set Address: Click the Set Address button to pop out the "Enter Set Address" pop-up box, enter the corresponding value and click Confirm to complete the modification of the communication address, as shown in Figure 3-5-43 below.

After-sales service: Click the after-sales service button to pop out the "Please enter the after-sales code" pop-up box, enter "8 6 1 0" and click OK to enter the after-sales service interface, as shown in Figure 3-5-44 and Figure 3-5-45 below.

Firmware upgrade: In the after-sales service interface, click Firmware Upgrade to bring up the "Please enter the firmware code" pop-up box, enter the firmware code "0 0 0" and click OK, the instrument starts the firmware upgrade, and the indicator light of the measurement module flashes rapidly at this moment, indicating that the firmware is in progress. During the upgrade, please wait patiently during the upgrade process, and do not perform other operations. After the upgrade is completed, the message "Upgrade Successful" will be displayed. The firmware upgrade sequence is as follows: Figure 3-5-46 Firmware upgrade 01, Figure 3-5-47 Firmware upgrade 02, Figure 3-5-48 Firmware upgrade 03. Note: After entering the firmware upgrade, please be sure to see that the firmware upgrade is successful before exiting.

Firmware update log: http://68.168.132.244/KG-F_DFU_log_EN.pdf

Extended service: Click the extended service button to pop out the "Please enter the password" pop-up box, enter "0 0 0 0" and click OK to enter the extended service interface, as shown in Figure 3-5-49 and Figure 3-5-50 below. Note: Please do not operate these functions if you do not know the full voltage, full current and power deficit voltage of the battery.

Restore factory settings: Click the Restore Factory Settings button to pop out the "Restore Factory Settings" pop-up box, select OK to restore the instrument to factory settings, as shown in Figure 3-5-51 below.

Restart the machine: Click the restart machine button to pop out the "Restart machine" pop-up box, select OK to restart the instrument, as shown in Figure 3-5-52 below.

Detection time: Click the detection time button to pop out the "Input detection time (0-20min)" pop-up box, enter the corresponding value and click OK to

complete the modification, as shown in Figure 3-5-53 below.

Full voltage: Click the full voltage button to pop out the "Input full voltage (0-120V)" pop-up box, enter the corresponding value and click OK to complete the modification, as shown in Figure 3-5-54 below.

Power loss voltage: Click the power loss voltage button to pop out the "Input power loss voltage (0-120V)" pop-up box, enter the corresponding value and click OK to complete the modification, as shown in Figure 3-5-55 below.

Full current: Click the full current button to pop out the "Input full current (0-20%)" pop-up box, enter the corresponding value and click OK to complete the modification, as shown in Figure 3-5-56 below.

Description of full power voltage, power deficit voltage, full power current, and detection time:

For example, for a 12V400Ah lead-acid battery, set the full voltage to 14.4V and the full current to 2%, which means that the full current is $400 \times 0.02 = 8\text{A}$, and the detection time is set to 2 minutes, which means that during the charging process, when the voltage is higher than 14.4 V. After the charging current is lower than 8A and the duration exceeds 2 minutes, the percentage of remaining capacity will be automatically adjusted to 100%;

Set the power-loss voltage to 10.5V and the detection time to 2 minutes, which means that when the voltage is lower than 10.5V during the discharge process and the duration exceeds 2 minutes, the percentage of remaining capacity will be automatically adjusted to 0% (if you feel that the power-loss voltage is this If the function is not very practical, you can set the full voltage, full current, and detection time without setting the voltage deficit);



Figure 3-5-30 Protection function

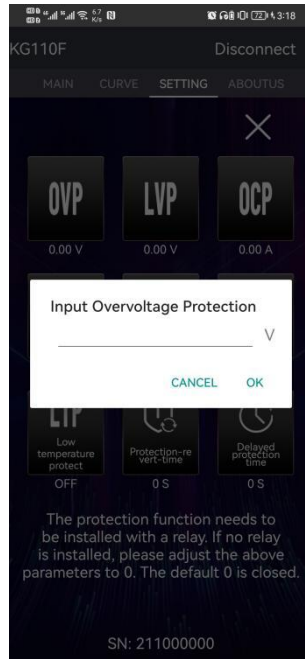

Figure 3-5-31 Overvoltage protection

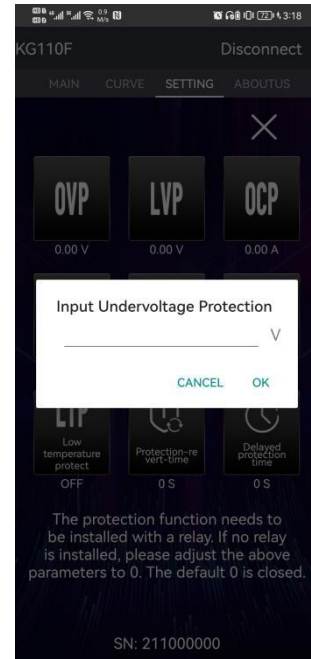

Figure 3-5-32 Undervoltage protection

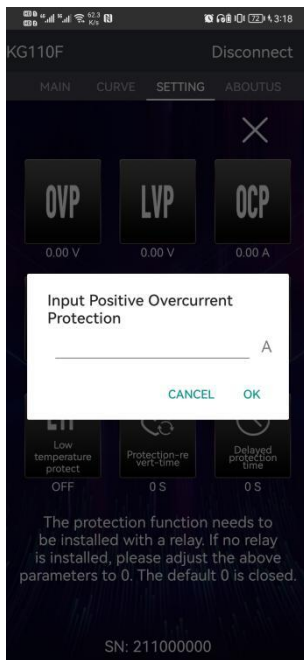

Figure 3-5-33 Discharge overcurrent protection

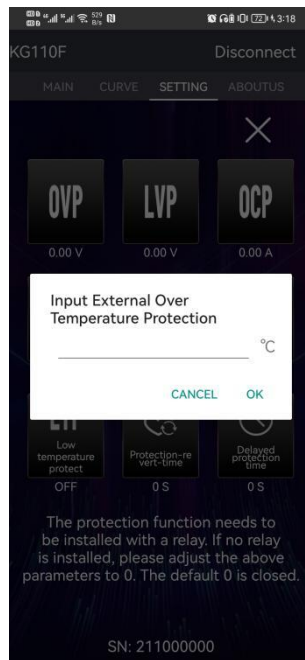

Figure 3-5-34 Over temperature protection

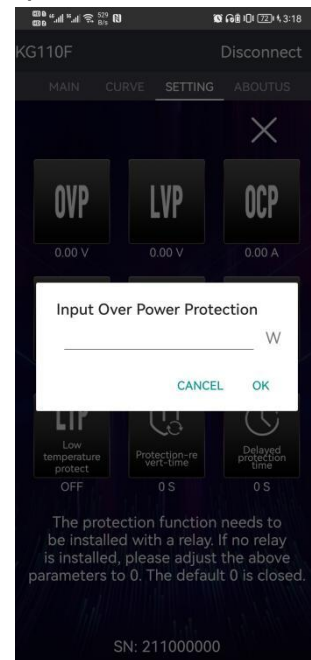

Figure 3-5-35 Overpower protection

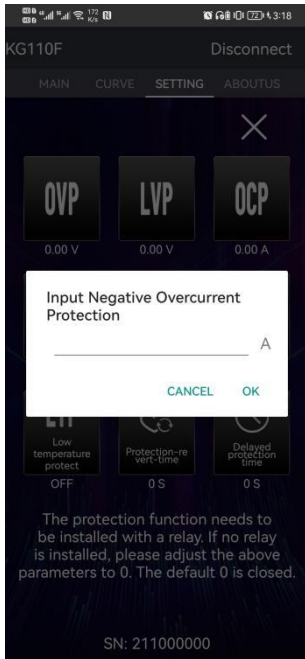

Figure 3-5-36 Charging overcurrent protection

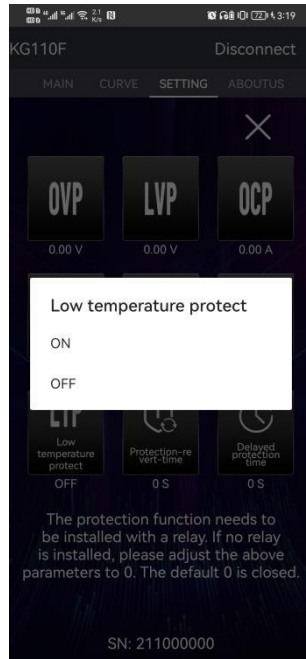

Figure 3-5-37 Low temperature protection 01

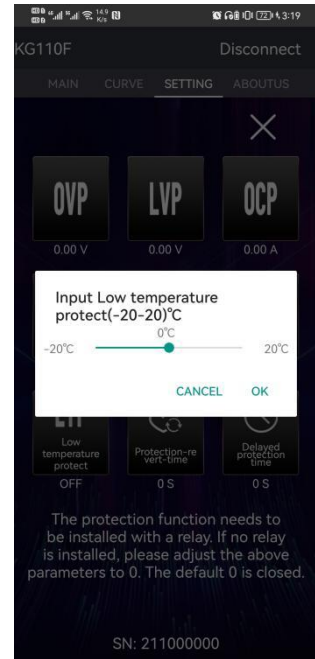

Figure 3-5-38 Low temperature protection 02

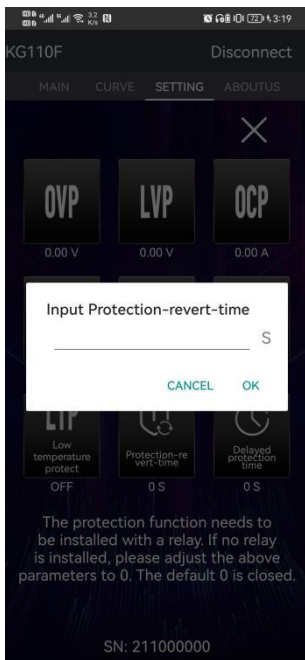

Figure 3-5-39 Protection recovery time

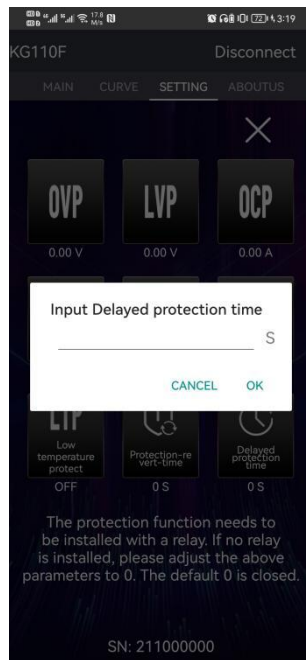

Figure 3-5-40 Delay protection time

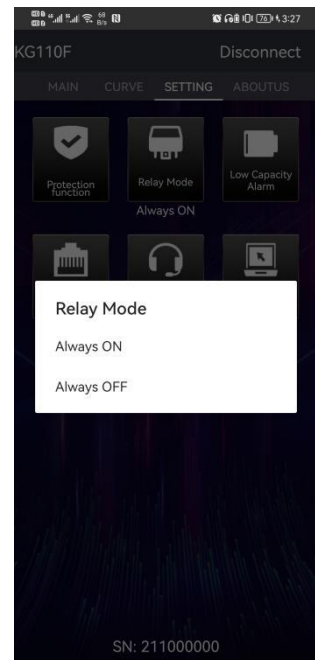

Figure 2-5-41 Relay type

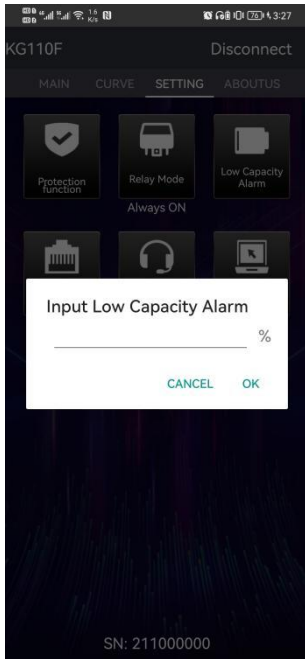

Figure 3-5-42 Low volume reminder

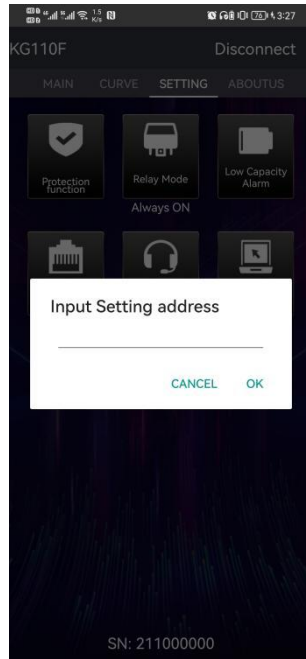

Figure 3-5-43 Setting address

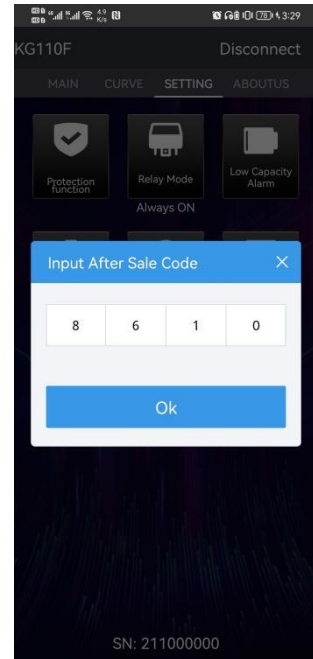

Figure 3-5-44 After-sale service 01

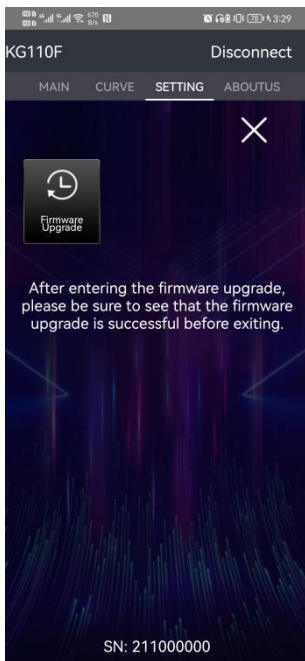

Figure 3-5-45 Low temperature protection 02

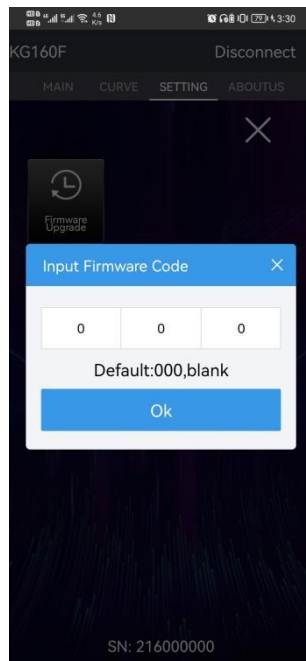

Figure 3-5-46 Firmware upgrade 01

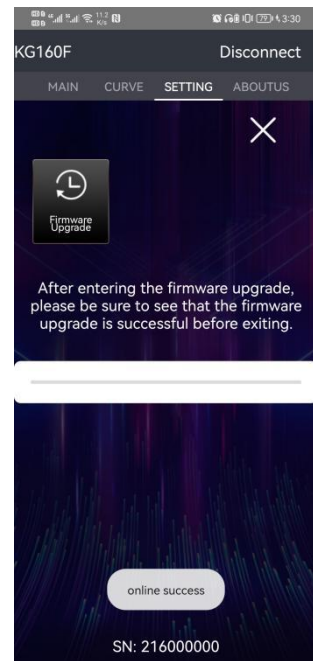

Figure 3-5-47 Firmware upgrade 02

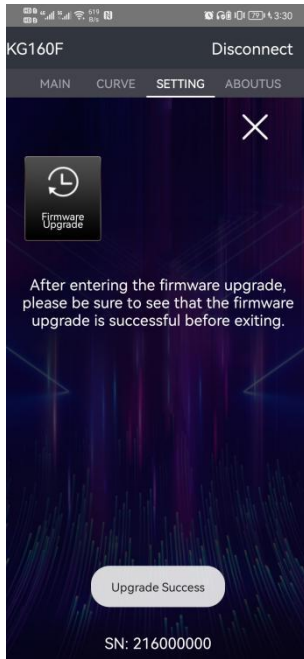

Figure 3-5-48 Firmware upgrade 03

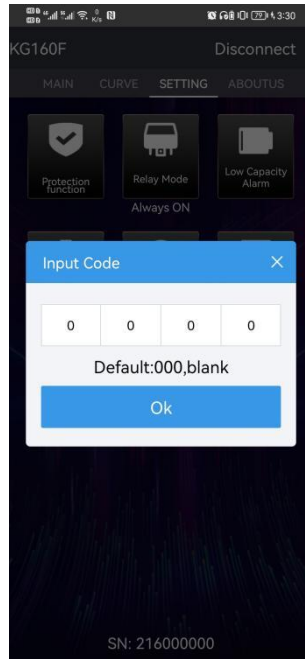

Figure 3-5-49 Extended function 01

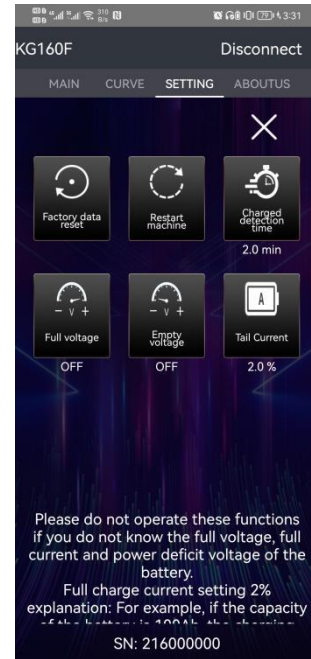

Figure 3-5-50 Extended function 02

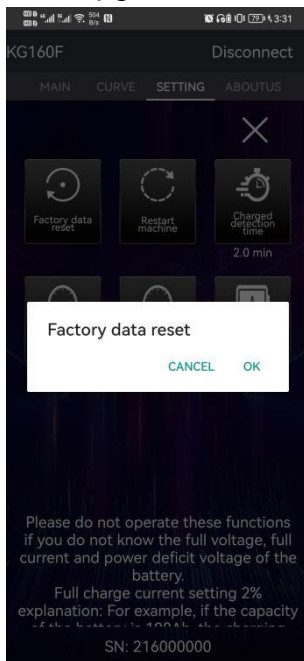

Figure 3-5-51 Restore factory settings

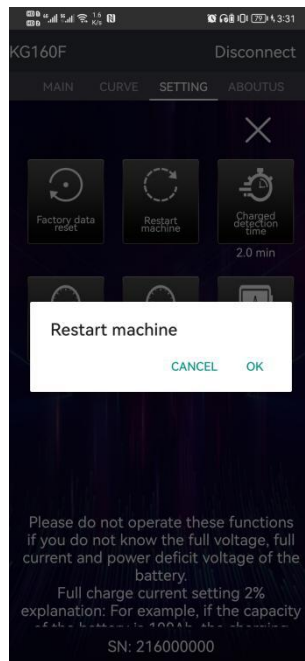

Figure 3-5-52 Restart the machine

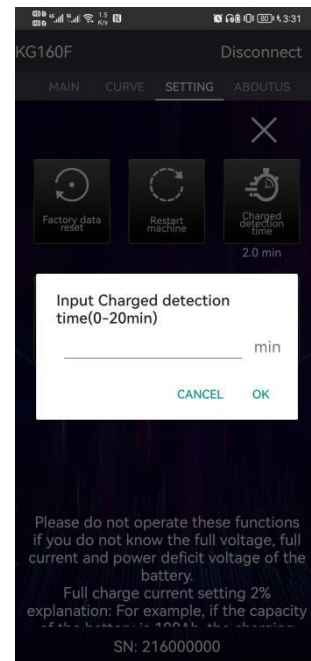

Figure 3-5-53 Detection time

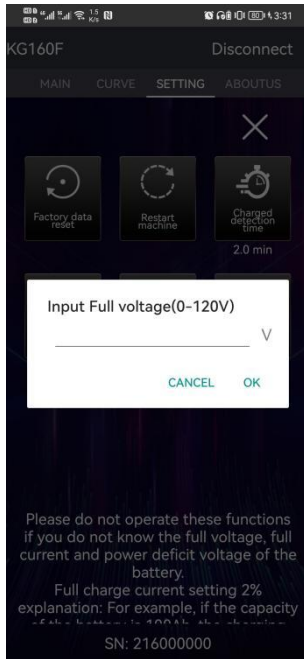

Figure 3-5-54 Full voltage

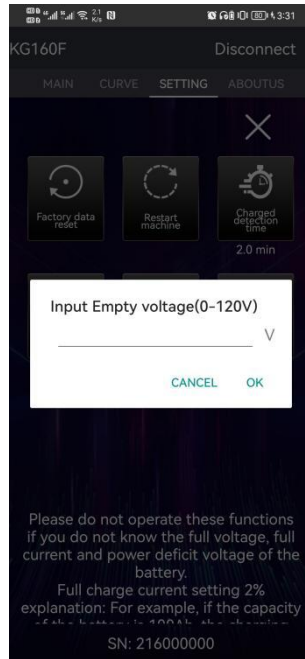

Figure 3-5-55 Deficit voltage

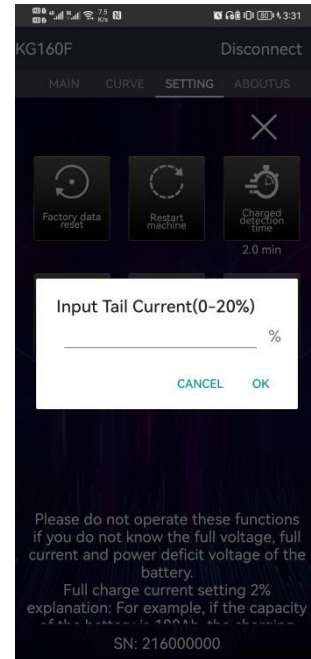

Figure 3-5-56 Full current

➤ About...interface operation

Version: you can view the software version information, as shown in figure 3-5-57.

Official website: after clicking the official website, you can jump to our company's official website, as shown in figure 3-5-58 below.

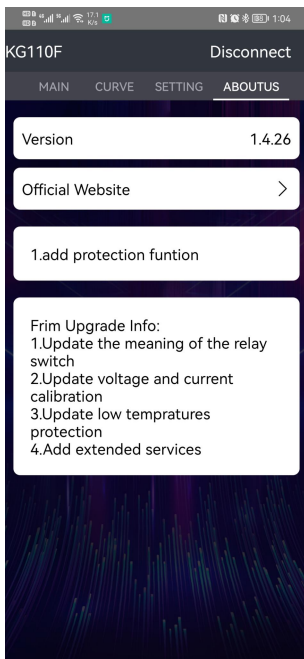

Figure 3-5-57 version



Figure 3-5-58 official website

2. App Instructions (For IOS)

Apple Mobile App installation and operation demonstration video:

<https://youtu.be/IFtG6Li8yfk>

(1) APP download

Search for “KG-F series” in the Apple Store to download.

(2) App software installation

The software only supports IOS 9.0 or above. Bluetooth will be accessed when the software is first linked. Please agree to visit.

Bluetooth module can not be plugged in and out of power state, which will cause damage. This manual corresponds to software version 1.2.1. Different versions may be slightly different. It is recommended to upgrade to the latest software to obtain better use experience.

(3) Software update

You can get the latest version from the Apple Store. The current manual corresponds to the IOS software version is 1.2.1.

(4) APP interface display



Figure 3-5-59
Main interface



Figure 3-5-60
Curve diagram

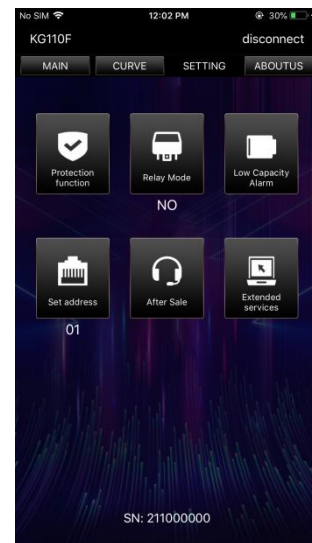

Figure 3-5-61
System settings

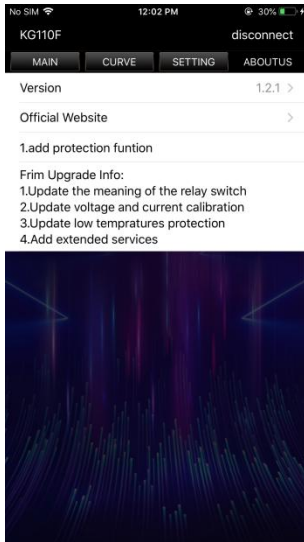

Figure 3-5-62 About us

(5) App operating instructions

The operation of IOS is the same as the Android.

Chapter IV Troubleshooting

The following lists the possible problems and troubleshooting methods of the KG-F series during use. When you encounter these problems, please follow the corresponding steps to deal with it. If you cannot deal with it, please contact **JUNCTEK** Hangzhou Junce Instruments Co., Ltd., and please provide your equipment information.

If the screen is still black after power on, and there is nothing display:

- Check whether the power wiring and the wiring between the display board and the main board are well connected.
- After finishing the above checks, restart the meter.
- If the product still cannot be used normally, please contact JUNCTEK.

If the screen display is too dark to see clearly:

- Check whether the brightness setting value of the LCD screen is too small. Press the **【SET】** button to enter the system setting interface, then press **【▲】** **【▼】** buttons to make the cursor on the working screen brightness. Press the **【OK】** button and then use the **【▲】** **【▼】** buttons to adjust the brightness of the LCD screen to a suitable state.

For more information about this product, please refer to the relevant manual (you can log in to the **JUNCTEK** official website (www.junteks.com) to download).

"KG-F series operation demonstration video" provides the operation video of this product.

"KG-F series PC software and communication protocol" provides the communication protocol.

"KG-F Series User Manual" provides the function introduction and operation of this product, possible problems and treatment methods during use.

Appendix 1: English and abbreviations of the interface

English	English abbreviation
Output State!	Output State!
Data Record	Data Record
Series number	SN
Display module version	Disp Mod Ver.
Measuring module version	Meas Mod Ver.
Remaining AH. value	AH.Rmn.
Elapsed AH value	AH.El.p.
Battery left	BatLeft
Battery internal resistance	IntRes
Language selection	Language
Set current to zero	Setcurrentto0
Clear accumulated data	Clear data
Preset battery AH. value	AH.Preset:
Percentage of remaining capacity	AH.Remaining:
Screen brightness	Brightness
Under-voltage protection	LVP
Over-voltage protection	OVP

Forward over-current protection	OCP
Negative over-current protection	NCP
Over power protection	OPP
Over temperature protection	OTP
Protection-revert-time	Revert Time
Enter standby time	Standby Time
Voltage calibration	Voltage Cal.
Current calibration	Current Cal.
Temperature calibration	Temp. Cal
Set address	Address
Set delay time	Delay Time
Current ratio	Current Ratio
Monitor function	Monitor
Relay Mode	Relay Mode
The scale of the voltage curve	Voltage Scale
The scale of the current curve	Current Scale
Restore to factory settings	Restore all
About	About
Enter the curve interface	Curve Interface
OK	OK
Cancel	Cancel
Voltage real-time curve	Voltage Curve
Current real-time curve	Current Curve
Voltage/current real-time curve	V/A Real-Time Curve
Voltage history curve	V History Curve
Current history curve	A History Curve
Voltage/current history curve	V/A History Curve
Voltage/current Curve	Voltage/current Curve
Voltage curve	V-Curve
Current curve	A-Curve

Normally open	NO
Normally close	NC
Completed	Completed
Failed	Failed
NO	NO
OFF	OFF